

brass
thread

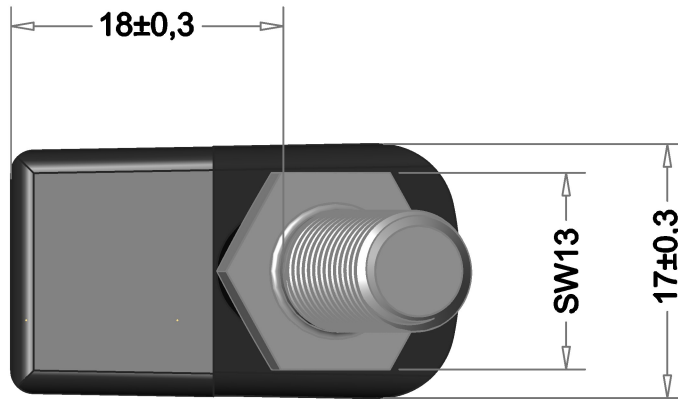

(1:1)

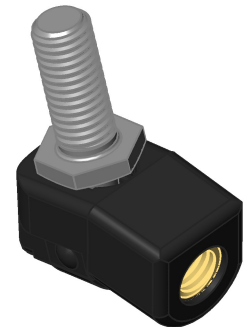

1- Ball socket (PL510188M.A16)
2- Ball stud (BS113208.0)

General Tolerances DIN ISO 2768-medium

(C) MK Material Oto. San. ve Tic. Ltd. Şti. All rights reserved.

Mea.	Tolerance	T. Max. Dim.	T. Min. Dim.	Material	Note
				PA66 GF30 + 11SMnPb30	-
	Name	Date	Signature	Plating	Quality control: () Product accepted. () Product rejected. () Product accepted conditionally. Date:
Drawn By				Zn/White	
Checked By					
Approved By					
Scale	Drawing No / Company Name			Rev. No	
2:1	PBJ510188M.A16.208.0			00	