

brass thread

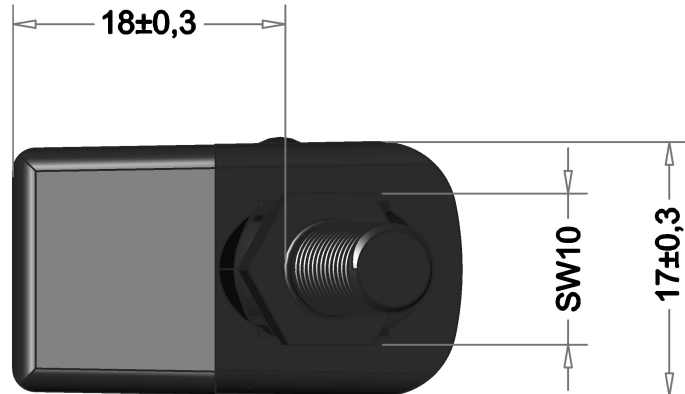

(1:1)



- 1- Ball socket (PL510186M.A16)
- 2- Ball stud (BS110156)

General Tolerances DIN ISO 2768-medium

(C) MK Material Oto. San. ve Tic. Ltd. Şti. All rights reserved.

Mea.	Tolerance	T. Max. Dim.	T. Min. Dim.	Material	Note
				PA66 GF30 + 11SMnPb30	-
	Name	Date	Signature	Plating	Quality control: <input type="checkbox"/> Product accepted. <input type="checkbox"/> Product rejected. <input type="checkbox"/> Product accepted conditionally. Date:
Drawn By				Zn/Black	
Checked By					
Approved By					
Scale	Drawing No / Company Name			Rev. No	
2:1	PBJ510186M.A16.156B			00	