

(1:1)

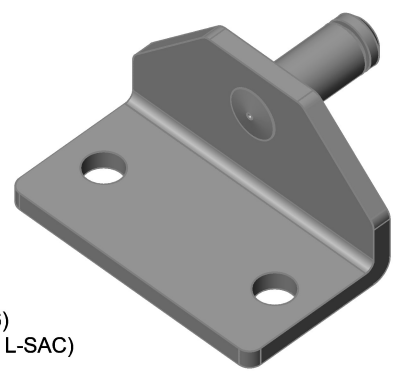

- 1 - Bolt (BB1108.456)
- 2 - Bracket (BR1011 L-SAC)

General Tolerances DIN ISO 2768-medium

(C) MK Material Oto. San. ve Tic. Ltd. Şti. All rights reserved.

Mea.	Tolerance	T. Max. Dim.	T. Min. Dim.	Material	Note
				Steel Sheet + 11SMnPb30	-
	Name	Date	Signature	Plating	Quality control: <input type="checkbox"/> Product accepted. <input type="checkbox"/> Product rejected. <input type="checkbox"/> Product accepted conditionally. Date:
Drawn By				Zn/White	
Checked By					
Approved By					
Scale	Drawing No / Company Name			Rev. No	
1:1	BR1011070			00	